



ZEA-35A is a series of high quality actuators intended for control of chilled water or hot water valves.

- * Three-point floating control, 24 or 230 V AC
- * Robust enclosure
- * Manual adjustment
- * Stroke preset at 40 mm

Function

ZEA-35A is a series of valve actuators intended for the most common plug type control valves available in the market.

The actuators are of the 3-point floating (increase-decrease) signal type. Options are available for a 135 ohm potentiometric feedback of the valve position or open/close limit switch.

Field of application

The actuator is used to operate valves for chilled water, hot water and steam applications.

Manual Override

Manual override is available as standard. The gearing can be disengaged by simply depressing the pushbutton on the side of the case. While the pushbutton is depressed, the actuator can be operated by hand and be set to any position.

Improved functional safety

The actuator stops automatically when it reaches the actuator end stop. Limit switches are pre-calibrated in the factory for 40 mm stroke.

Simple installation

The actuator is fitted with a universal "C" clamp for quick and easy mounting directly on the valve connector. Coupling nuts can be provided for all type of connection - mushroom head or screw joints. Red and blue indicators on the linkage bracket provide visual indication of the valve position.

Note: The valve actuator can be adapted on valves of other brands. Please consult factory for full range of accessories for adapting onto valves of other make.

Models

	Control signal	Supply voltage	Force
ZEA-35A-24	Three-point	24 V AC	3500 N
ZEA-35A-230	Three-point	230 V AC	3500 N

Technical data

Supply voltage	24 VAC or 230 VAC
Control signal	3 point floating
Transformer sizing	16.5 or 10 VA
Stroke	40 mm preset, adjustable at site with end limit switches
Stroke time	105 s
Force	3500 N
Ambient temperature	-5...50 °C
Storage temperature	-30...65°C
Ambient humidity	Max 95% RH
Cable connection	Screw terminals
Degree of protection	IP54
Weight	3.6 Kg

Wiring and dimensions

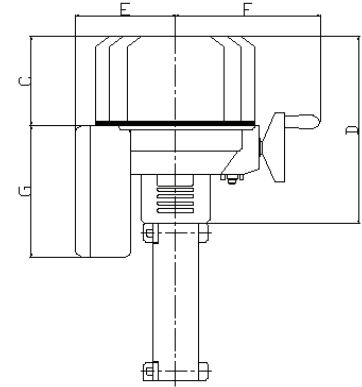
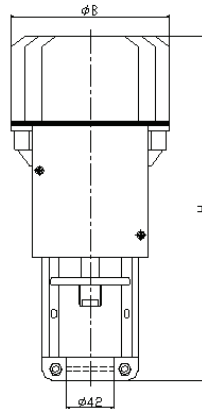
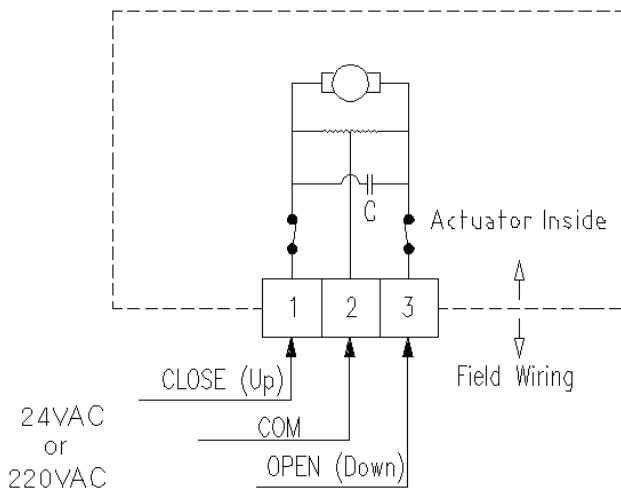

B	138
H	298
D	162
F	126
E	87
G	126
C	77

