



ZEA-20P is a series of high quality actuators intended for control of chilled water or hot water valves.

- * Modulating control 0(2)-10Vdc
- * Robust enclosure
- * Manual override
- * Automatic stroke adjustment

Function

The ZEA-20P is a series of valve actuators intended for the most common plug type of control valves available in the market.

The actuators are of modulating (0(2)-10Vdc) signal type. Modulating model can also accept 4 - 20 mA input signal. Optionally, a feedback signal of 0 - 10 Vdc/4 - 20 mA can be provided for interfacing to position indicators.

Field of application

The actuator is used to operate valves for chilled water, hot water and steam applications.

Manual Override

Manual override is available as standard. The gearing can be disengaged by simply depressing the pushbutton on the side of the case. While the pushbutton is depressed, the actuator can be operated by hand and be set to any position.

Improved functional safety

The actuator of the modulating type has built in torque switches for overload protection. It stops automatically when it reaches the actuator end stop. The stroke can be automatically adjusted at site and is pre-calibrated in the factory for 20 mm travel.

Simple installation

The actuator is fitted with a universal "C" clamp for quick and easy mounting directly on the valve connector. Coupling nuts can be provided for all type of connection - mushroom head or screw joints. Red and blue indicators on the linkage bracket provide visual indication of the valve position.

Note: The valve actuator can be adapted on valves of other brands. Please consult factory for full range of accessories for adapting onto valves of other make.

Models

	Control signal	Supply voltage	Force
ZEA-20P-24	0...10 Vdc	24 V AC	2000 N

Technical data

Supply voltage	24 VAC or 230 VAC
Control signal	0...10 Vdc, 2...10 Vdc, 4...20 mA
Transformer sizing	16.5 or 10 VA
Stroke	20 mm preset, adjustable at site
Stroke time	55 s
Force	2000 N
Ambient temperature	-5...50 °C
Storage temperature	-30...65°C
Ambient humidity	Max 95% RH
Cable connection	Screw terminals
Degree of protection	IP54
Weight	3.7 Kg

Wiring and dimensions

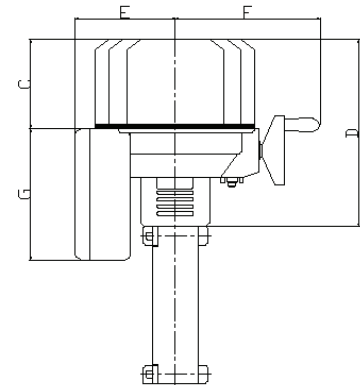
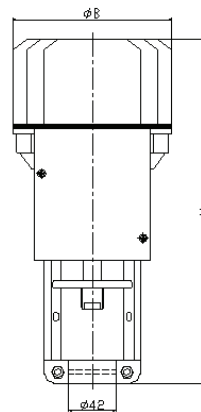
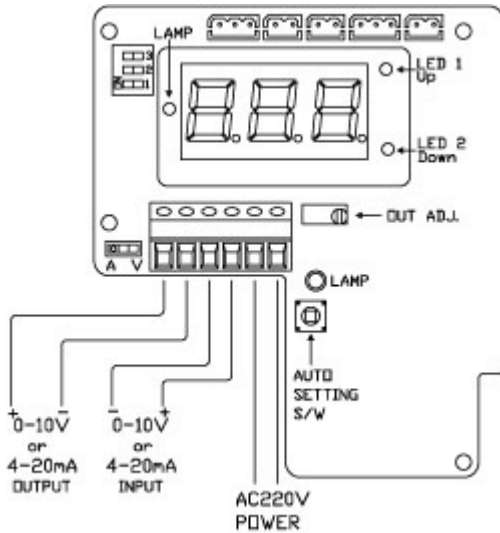
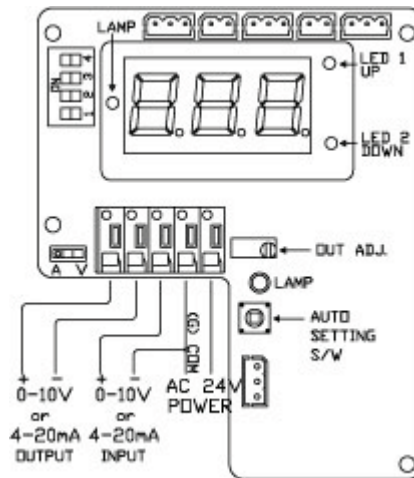
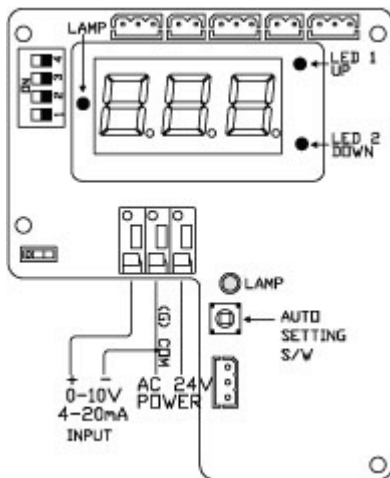

B	138
H	271
D	162
F	126
E	87
G	126
C	77